

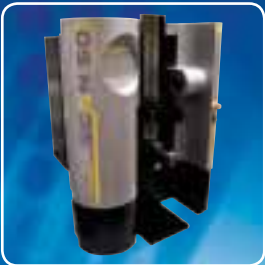

**BOWERS GROUP**

THE ESSENTIAL METROLOGY CATALOGUE **16/17**



Partners in Precision

8VAVI dc







## Trimos THV Mini Horizontal Calibration Machine

The flexible Trimos THV Calibration Machine is capable of undertaking a wide range of internal and external calibration routines, belying its relatively inexpensive price. This flexible instrument can be supplied fitted with a variety of probes, scales and readouts, including Heidenhain units, dependent on the customers required accuracy specification.



The large range of ingenious, quick-fit accessories available for the THV, ensures great versatility of application. Simplicity of design and ease of use of the instrument allows rapid and accurate calibration of a wide variety of measuring instruments.

The basic instrument is supplied with a set of 6.5mm diameter carbide anvils for external measurements and a set of anvils for internal measurements, minimum diameter 10mm. Smaller diameters available on request.

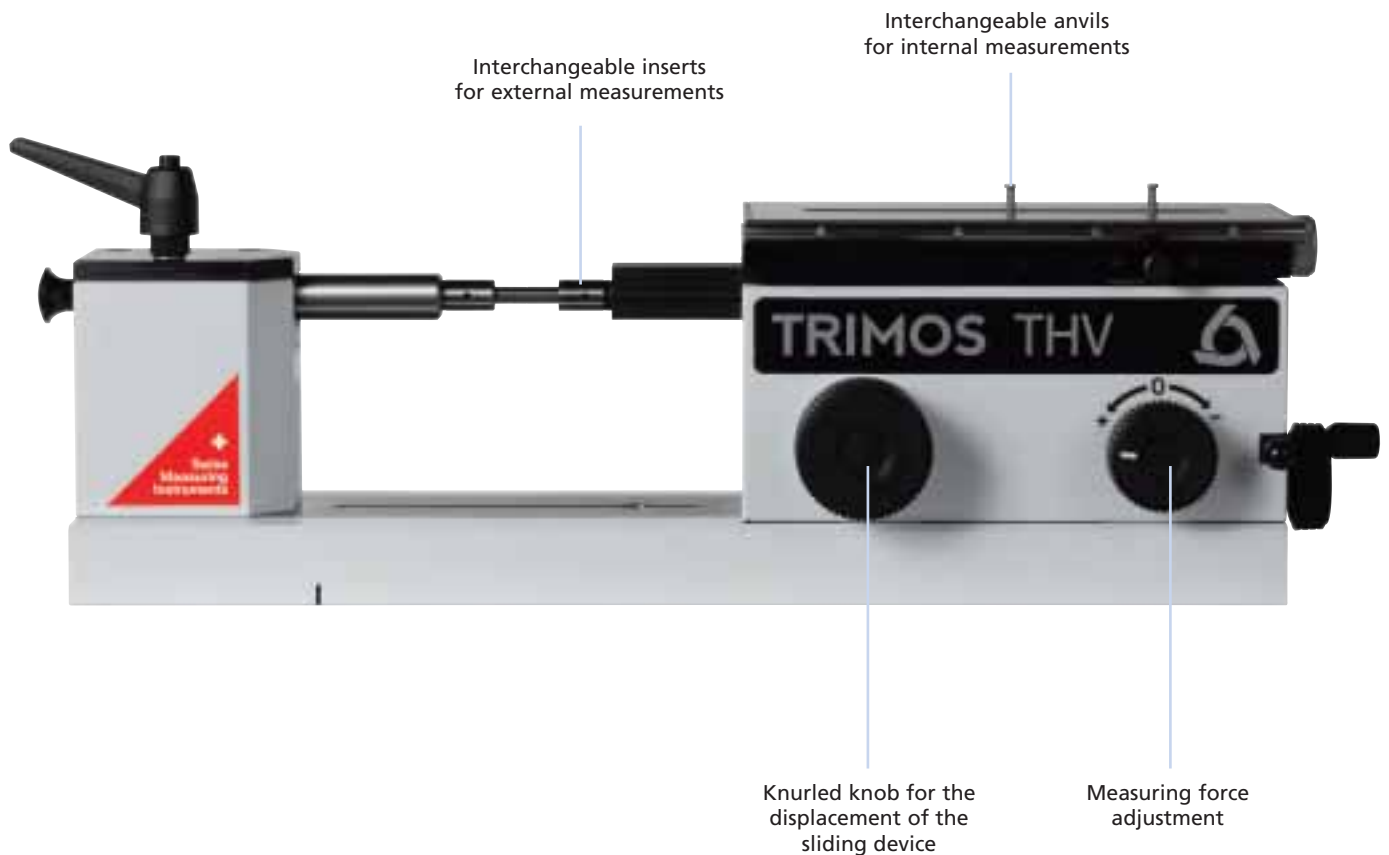

### FEATURES WITH HEIDENHAIN READOUT

	Trimos THV
Measuring range	0-100mm / 4"
Absolute measuring range	0-50mm / 2"
Resolutions	0.1 - 0.00001mm / 0.0001 - 0.000001"
Repeatability	0.1µm
Measuring Force	0 - 4N
Accuracy over 50mm scale range	0.2+L (mm) / 250
Operational temperature	+10 - +40°C
Temperature of storage	-10 - +40°C
Functions	Min / Max / TIR Preset
Output	RS232 output (USB)
Weight	22kg

Extensive range of accessories available - please request detailed literature.



## Trimos Accessories

Versatility of application is ensured by a large range of accessories for checking all types of gauges. The simplicity of the instrument and its ease of use allows quick and precise measurements.



1) Checking of test indicators



2) Measuring of precision parts



3) Checking of plain and threaded plug gauges using the floating table



4) Checking of internal diameters



Heidenhain Display



TFT/Touch screen option with TRIMOS-WinDHI software for all required measuring functions

### HORIZONTAL/VERTICAL CALIBRATION INSTRUMENTS

Code No	Description
20-3300	THV with fixed table Heidenhain display
20-3301	THV with floating table Heidenhain display
20-3302	THV with fixed table D300S display P25 probe
20-3307	THV with fixed table PC display with WinDHI
20-3309	THV with floating table PC display with WinDHI

For a complete list of accessories, please contact the sales office.

## Trimos Horizon 'H' Series Length Measuring Machine



### Features

- Ideal for use in the workshop area
- Very simple operation
- Precise checking and setting made easy
- Self-contained operation of approx. 100 hours
- Incorporated rechargeable battery pack
- Clearly defined display unit
- Wide selection of accessories available (please request Trimos catalogue for details)
- Up to 8000mm size on request

### TRIMOS HORIZON "H" SERIES

Code No	Description
20-H500	Trimos H501 Horizon, V-series display
20-H1000	Trimos H1001, Horizon, V-series display
20-H1500	Trimos H1501, Horizon, V-series display
20-H2000	Trimos H2001 Horizon, V-series display

### TECHNICAL SPECIFICATION

	H501	H1001	H1501	H2001
Measuring range	520mm / 20"	1020mm / 40"	1520mm / 60"	2020mm / 80"
Measuring system	Sylvac system			
Max. permissible errors	2.5+L(mm)/300			
Repeatability (+/- 2s)	Reference temperature 20 deg C, relative humidity 50%			
Display	1µm / 0.00004"			
Resolution (switchable)	LCD digital display, Sylvac-System			
Measuring force	0.01 or 0.001mm or .0001 / 0.00001"			
Maximum displacement speed of the measuring carriage	3N			
Data output	1500mm/s			
Operational temperature limit	RS232C			
Weight	92kg	118kg	143kg	168kg
<b>Up to 8000mm size on request</b>				



# Trimos Horizon Premium

The Trimos 'Horizon' Series of Horizontal Machines are capable of setting, checking and calibrating a wide range of gauges. The availability of the machine in a range of sizes and wide variety of holders and adapters further improves the usefulness of these quality instruments.



TFT/Touch screen option with TRIMOS-WinDHI software for all required measuring functions (DIGITAL) HPD



Heidenhain Display (ANALOGUE) HPA



## TRIMOS HORIZON PREMIUM

Code No	Description
20-32550	Trimos HPA500 Horizon, Heidenhain display
20-321050	Trimos HPA1000 Horizon, Heidenhain display
20-321550	Trimos HPA1500 Horizon, Heidenhain display
20-322050	Trimos HPA2000 Horizon, Heidenhain display
20-323050	Trimos HPA3000 Horizon, Heidenhain display
20-34550	Trimos HPD500 Horizon, Premium digital
20-341050	Trimos HPD1000 Horizon, Premium digital
20-341550	Trimos HPD1500 Horizon, Premium digital
20-342050	Trimos HPD2000 Horizon, Premium digital
20-343050	Trimos HPD3000 Horizon, Premium digital
20-HPA500E	Trimos HPA500E Horizon, Heidenhain display*
20-HPA1000E	Trimos HPA1000E Horizon, Heidenhain display*

\* Trimos H Series TEL 5 anvils and force loading mechanism

## Features

- Suitable for the shopfloor or inspection room
- Available in 5 different capacities ranging from 0-550mm up to 0-3050mm
- Separate digital readout, PC display or touchscreen option
- For machine Specifications and Accessories available on request



## Trimos Labconcept and Labconcept Premium Calibration Machines

The Trimos Labconcept represents the latest developments in the field of multifunction calibration machines. Capable of calibrating an extremely wide range of measuring instruments with incredible speed and accuracy the instrument is now the calibration machine of choice for some of the biggest UKAS and factory laboratories throughout the UK and beyond.



The wide range of quick-change ingenious accessories and holders facilitates the accurate calibration of an exceedingly wide range of measuring instruments. Utilising the user-friendly QM software, the instrument can rapidly send its findings to a gauge-management module or generate calibration certificates instantly.



### TRIMOS LABCONCEPT CALIBRATION MACHINE

Code No	Range (mm)	Range (inch)	Maximum Error	Repeatability ( $\mu\text{m}$ )	Resolution (mm)	Resolution (inch)	Force	Weight
20-32500	550	21	0.3 + L (mm)/1500	0.1 (2s)	0.01-0.00001	0.0001-0.00001	0-12N	94kg
20-321000	1050	41	0.3 + L (mm)/1500	0.1 (2s)	0.01-0.00001	0.0001-0.00001	0-12N	123kg
20-321500	1550	61	0.3 + L (mm)/1500	0.1 (2s)	0.01-0.00001	0.0001-0.00001	0-12N	152kg
20-322000	2050	80	0.3 + L (mm)/1500	0.1 (2s)	0.01-0.00001	0.0001-0.00001	0-12N	181kg
20-32300P	370	14	0.1 + L (mm)/2000	0.05 (2s)	0.01-0.00001	0.0001-0.00001	0-12N	78kg
20-325000P	550	21	0.15 + L (mm)/2000	0.05 (2s)	0.01-0.00001	0.0001-0.00001	0-12N	95kg
20-321000P	1050	41	0.15 + L (mm)/2000	0.05 (2s)	0.01-0.00001	0.0001-0.00001	0-12N	125kg



# Trimos Labconcept and Labconcept Premium Calibration Machine Applications



Checking of ring gauges



Checking of plug gauges



Checking of small ring gauges



Checking of screw ring gauges



Checking of thread plug gauges



Checking of micrometers

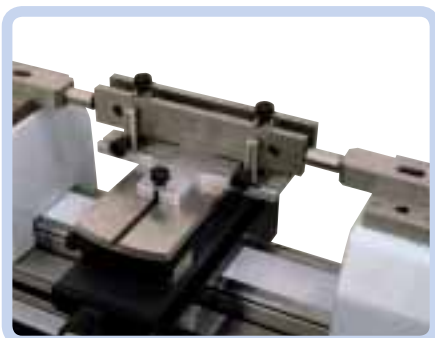

Checking of gauge blocks



Checking of long series gauge blocks

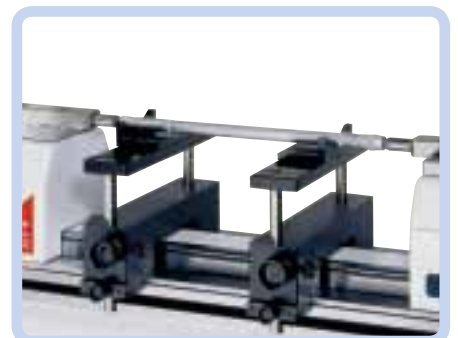

Setting of 2-point comparative measuring equipment

## Features

- Large measuring range 0-14" (0-370mm) and 0-79" (0-2050mm)
- Developed for EN ISO 9000/2000 standards
- Switchable resolution; 0.0001", 0.00001", 0.000001", or 0.001mm, 0.0001mm, 0.00001mm
- Wide range of easily interchangeable accessories
- Adjustable measuring force 0-12N
- Displacement speed of measuring carriage: Labconcept 1500mm/s, Labconcept Premium 400mm/s
- Fine adjustment range = 0.394" / 10mm
- Operational temperature limit 10°-40°C
- Operational humidity limit 20-80%

## Trimos Labconcept Nano Calibration Machine

The Labconcept Nano is a new reference in the field of dimensional metrology. The result of a unique combination of the most recent developments in technology and Trimos' expertise in the metrology market, comes an outstanding instrument adapted to perform all dimensional measuring tasks requiring extreme high accuracy.



With the Trimos Labconcept Nano it is possible to check all kinds of gauges as plain ring gauges, plain plug gauges, pins, threaded ring and plug gauges, conical thread ring and plug gauges, gauge blocks, snap gauges, gauge bars etc. The sizes of all gauges can be considered by selecting the required model (350mm / 600mm / 1100mm).



### TECHNICAL SPECIFICATION

Max. permissible errors ( $\mu\text{m}$ )	$0.07+L(\text{mm})/2000$
Max. resolution (mm/inch)	0.00001 (0.0000004)
Repeatability (2s) ( $\mu\text{m}$ )	0.03
Measuring force (adjustable by software) (N)	0-12
Time measuring a plain ring (sec)	40
Time measuring a thread ring (sec)	50
Movement of X axis	motorised
TFT screen	1 x TFT touch screen / 1 normal screen
Interface	PC-Dell
Temperature compensation	Yes, with 2 sensors
Measuring table with motorised Y and Z axis	Yes
Z axis, displacement range (mm)	100
Y axis, displacement range (mm)	50
X axis, floating movement (mm)	$\pm 10$
Angle of rotation $\emptyset$ Y ( $^{\circ}$ )	$\pm 1.5$
Angle of inclination $\emptyset$ Z ( $^{\circ}$ )	$\pm 4$
Operational temperature ( $^{\circ}\text{C}$ )	+15 $^{\circ}$ to 35 $^{\circ}\text{C}$
Stocking temperature ( $^{\circ}\text{C}$ )	-10 $^{\circ}$ to 50 $^{\circ}\text{C}$
Relative humidity (%)	20 .. 80

### LABCONCEPT NANO

Code No	Range (mm)	Range (inch)	Application Range (mm)	Application Range (inch)	Weight
20-32350N	350	14	0-350	0-14	350kg
20-32600N	350	14	0-600	0-24	420kg
20-321100N	350	14	0-1100	0-44	500kg



# Trimos Labconcept Nano Calibration Machine



Swiss Precision



Plain ring gauge from 15mm up to 250mm

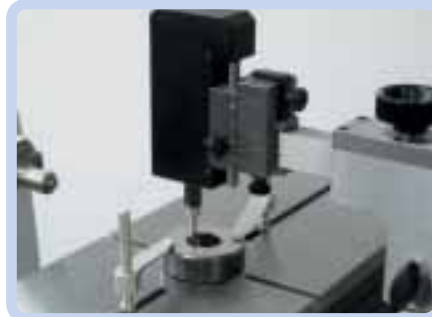

Plain ring gauge from 1mm up to 20mm



Plug gauges / pins without centers up to dia. 100mm



Thread plug gauges between centers up to 100mm



Threaded ring gauges from M3 up to M180

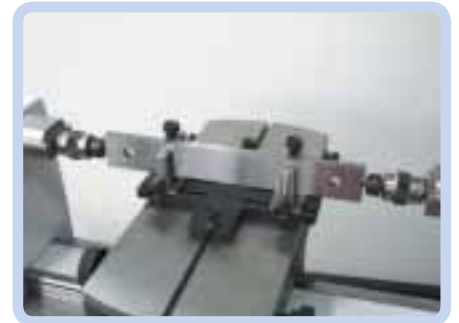

Checking of gauge blocks up to 250mm (250 to 1000mm)



Gauge bars from 100mm (up to the instrument range)

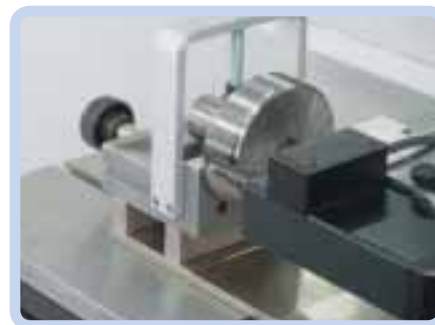

Checking of taper thread gauges (plug/ring gauges)

A large range of accessories is available as standard. Accessories to suite special applications can be supplied.

## Features

- Unequaled high level of accuracy:  $0.07\mu\text{m} + L/2000\text{mm}$
- Exceptional repeatability:  $0.03\mu\text{m}$
- Motorised measuring carriage, X axis, selection of speed by software
- Motorised universal measuring table, Y/Z axis. 60Kg range
- Measuring force (0-12N) and locking of measuring anvil performed by software
- Integrated temperature compensation system (2 sensors)
- Integrated gauge management software (optional)

## Flatness Calibration & Machine Tool Verification

The Wyler Electronic Levelling System is now well established in the field of flatness calibration. The Blue System set shown below has an output signal allowing it to be used to produce in-depth results and print-outs using a variety of methods and software programs.



### Features

- Differential measurement eliminates errors caused by vibration
- Calculates an average of 64 inputs per measurement
- Range for 99 measuring points for lines, 1000 for surfaces
- Graphic results can be printed or retained on disc for reference
- Software conforms to British Standard

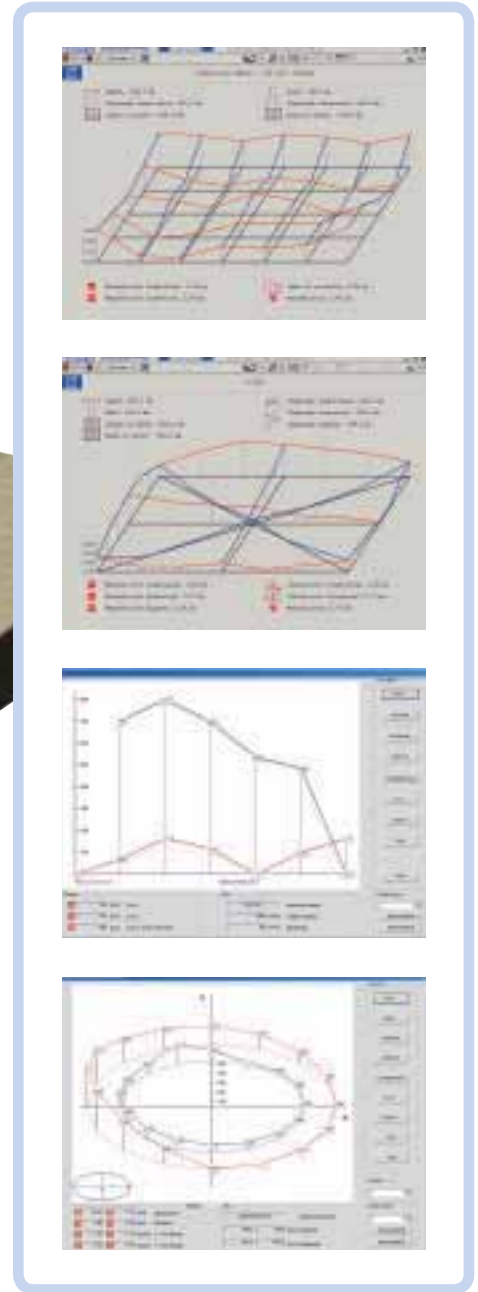

### LEVELSOFT PRO SOFTWARE

Code No	Description
60-6168L	Levelsoft Pro Light Software (Line and Surface Calibration Only)
60-6168	Levelsoft Pro Software (Full Version) Software Only
60-6168BW	Levelsoft Pro Software (Full Version) with cables for Wyler Blue System
60-MTSOFT-D	MTSOFT Machine Tool Verification Software (Full Version)
60-MTSOFT1-D	MTSOFT Basic Package incl Guideways and Rotating Elements
60-MTSOFT2-D	Circles
60-MTSOFT3-D	Partial Surfaces
60-MTSOFT4-D	Rotation and Machine Elements
60-MTSOFT5-D	Levelsoft Pro as Part of MTSOFT
60-MTSOFT6-D	Comparison of Elements

### Computer software program offers the following solutions

<b>Line</b>	Straightness of guideways and machine tool beds.
<b>Line / Twist</b>	Straightness and twist of bedways, straight edges and rails
<b>Parallels</b>	Straightness and parallelism of bedways etc.
<b>Parallels / Twist</b>	Straightness, twist and parallelism of bedways
<b>Rectangle</b>	Flatness of surfaces and machine tool beds
<b>Union Jack / Grid</b>	Flatness of surface plates and tables



**BOWERS GROUP**



**Machine DRO**

EtcYVgGdVY, =dYYZHdc, =Zg [dgYh] gZ, : C&&%7O

**Tel:** %&. . ' ) \*\* . ' &

**Email:** sales@b Vx] cZ!Ygd.co.uk

**Website:** | | | #b Vx] cZ!Ygd#d#`

